

Spectra

SB63CU

Double Bowl Copper Sink

All dimensions in mm

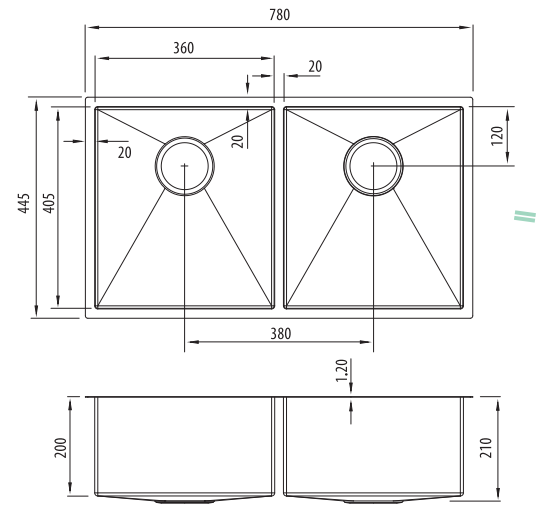

Specifications /

Sink size	780W x 445H mm
Bowl size	Main Bowl 360W x 405H x 200D / 29L Main Bowl 360W x 405H x 200D / 29L
Construction	Fabricated with 5mm radius corners, Softtone® and soundproofing
Material	304 grade, 18/10 coloured stainless steel (1.2 mm thick)
Installation	Topmount, undermount or flushmount
Fixings	Topmount clips supplied only
Min cabinet size	900 mm
Tap holes	N/A
Waste fittings	2 x 90 mm coloured basket wastes included
Overflow	Not available
Carton size	880 x 540 x 330 mm
Weight	21 kg
Warranty	Lifetime manufacturer's warranty (refer to oliveri.com.au)
Maintenance and care instructions	All surfaces should be cleaned with mild liquid detergent or soap and water. To maintain the shine on your Oliveri stainless steel sink, we recommended the use of any of the easy to obtain, non-abrasive stainless steel cleaners or metal polishes.

Included accessories /

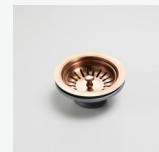

ACBWCU
Basket Waste



ACBWCU
Basket Waste



ACBPCU-2
Bowl Protector



ACBPCU-2
Bowl Protector



ACP104F
Bamboo Board



ACP109CU
Bench Top
Drainer Tray

